



I'm looking forward to the office

## Office space to feel good in

We spend a large part of our lives at the office.

With individualisable office furniture Palmberg wants to make sure that workplaces become real places of well-being. The more comfortable we feel in the office, the better and more effectively we work. An office design that consider individual needs of employees should therefore also be in the interest of companies.

In a time in which the demands on modern as working environments change ever faster, we rely not only on the results of scientific studies when developing innovations, but also on our gut feeling and decades of experience. It is our goal that you will hear this statement as often as possible: „I'm looking forward to the office.“





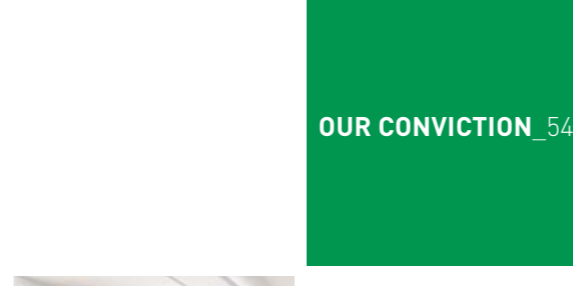
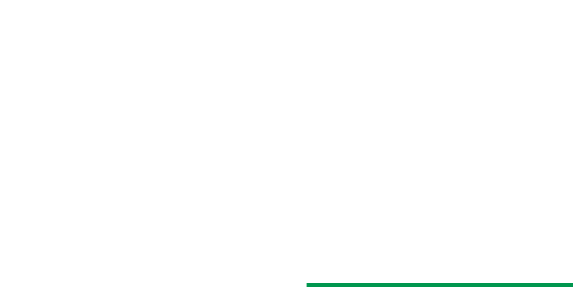
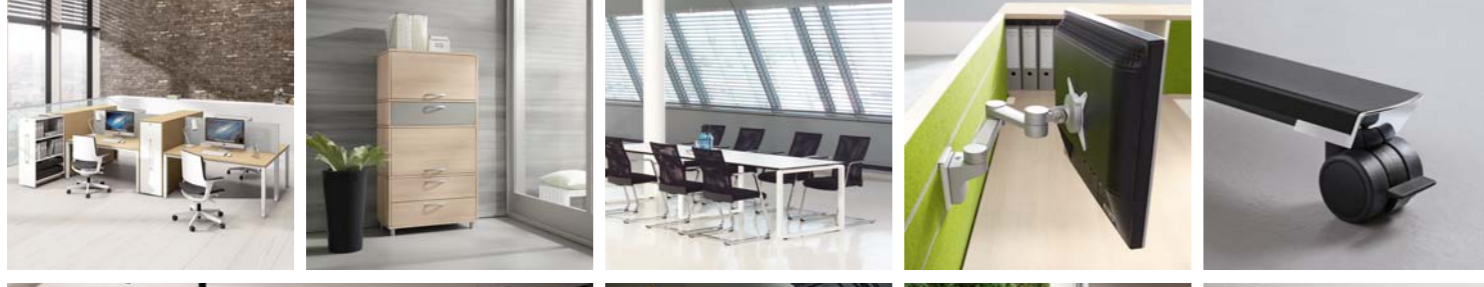
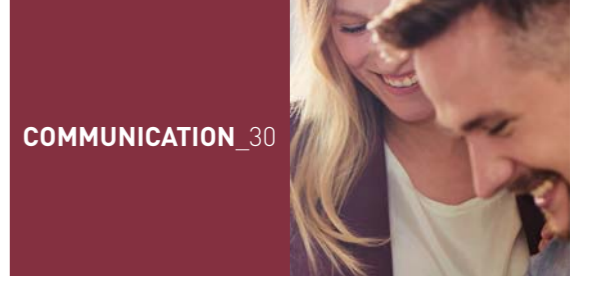
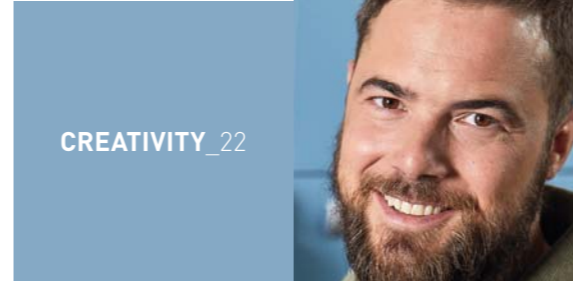



▶ SCAN AND WATCH VIDEO

Standing meetings are

**30%**

shorter and deliver better results.\*

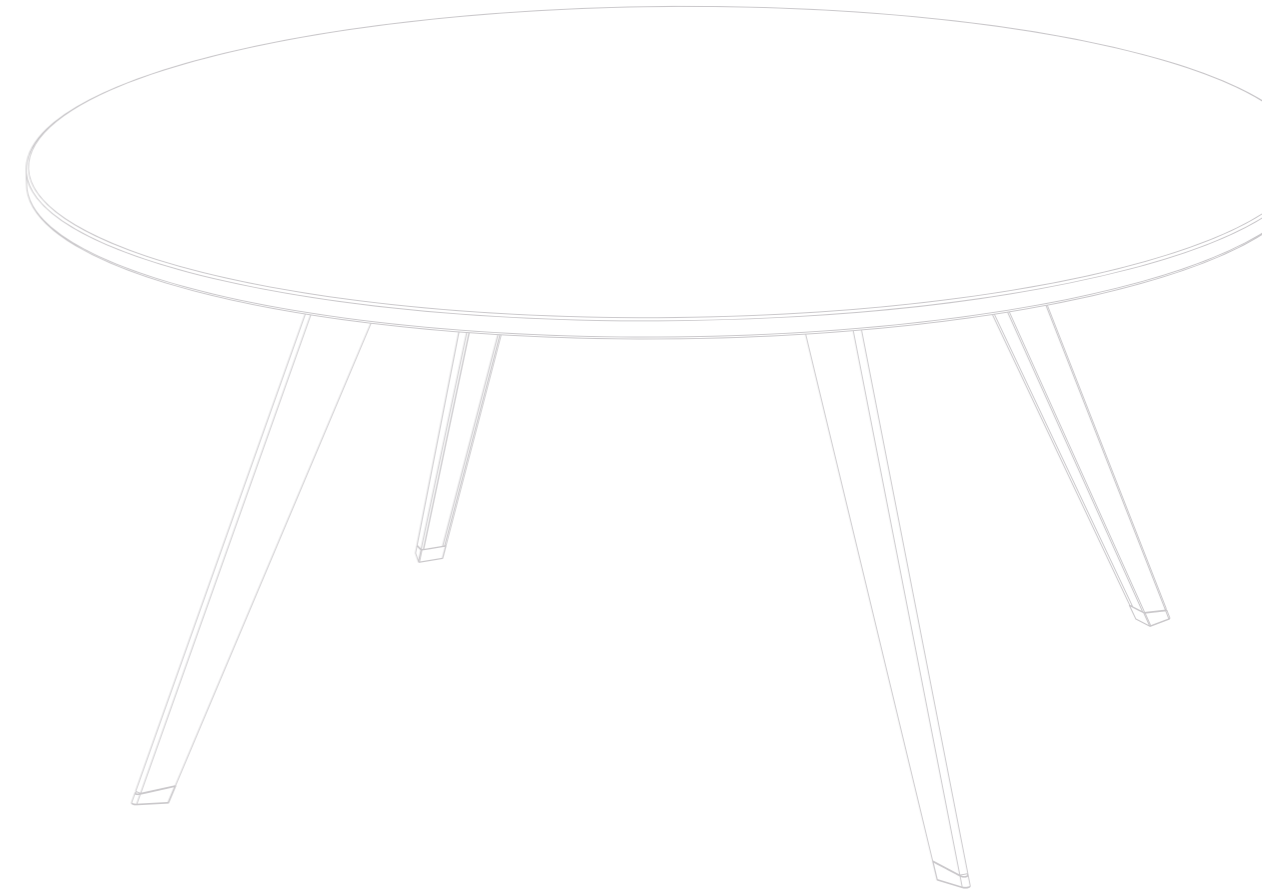

## MEETING

According to a study by the University of Augsburg, 44.6% spend Half of her working time in meetings. It's only natural, to of office workers spend half of their working time. The elegant Meeting tables of the **CONFERENCE** series offer all the necessary possibilities. Besides countless equipment variants some models are height adjustable by an electric motor or also available as stand-up version- and can thus reduce the meeting time by up to 30%. That's almost.



Talks  
at eye level



Room for good communication can be in many places. PALMBERG offers a wide range of solutions for large and small meeting situations. Of course, classic seminar and training constellations can also be created with our flexible programs.

For every style of furnishing and each meeting situation the optimal meeting solution - that is **CONFERENCE**.





**VERSATILE  
DYNAMIC  
FLEXIBLE**

**Always keep moving:  
height-adjustable conference tables**

With the electromotive height-adjustable conference table BANDO from the series **CONFERENCE** you get a stable frame in clear design. Height adjustment from 720 mm up to 1080 mm is no problem.







▶ SCAN AND WATCH VIDEO

Noise pollution  
decreases the  
output by up to

**30%.\***

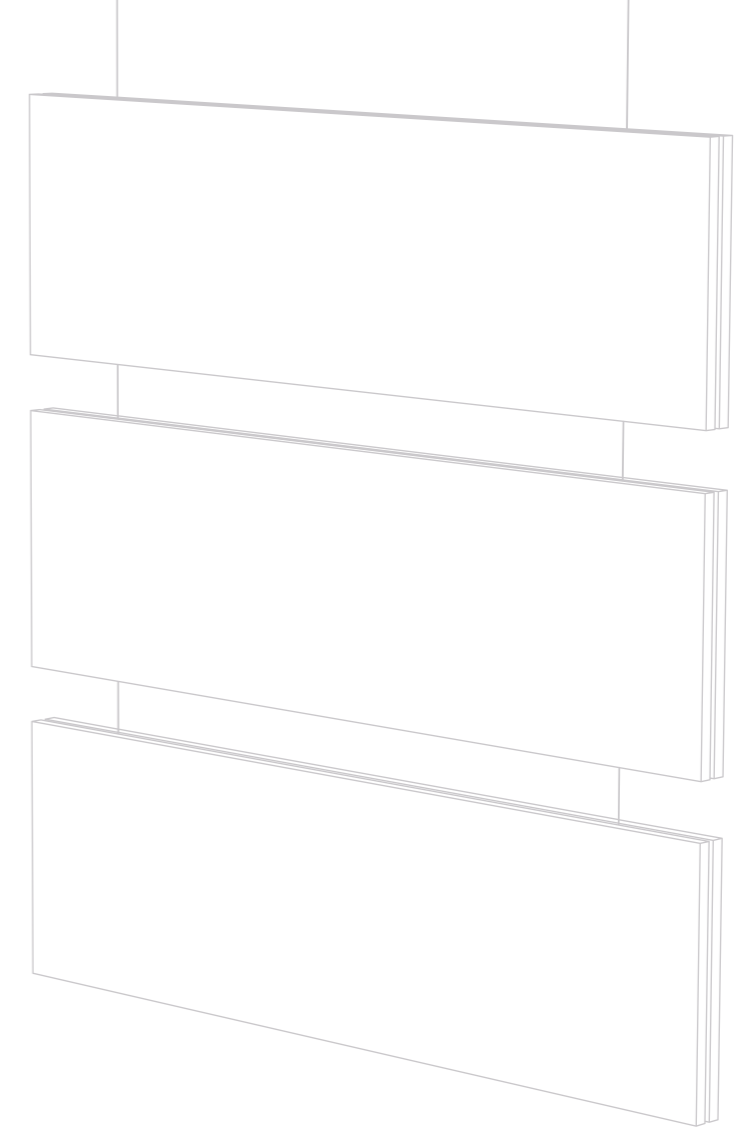

## ACOUSTICS

In many companies impairment of work motivation through acoustic disruptions are still greatly underestimated - so the willingness to solve technical problems in noisy offices for example declines by 40%. For many years we have been working together with experts to find effective solutions for noise reduction. The increasing demand and many customer voices confirm again and again: Acoustic solutions can also look great.



**SILENCE TO THE EARS -  
CANDY TO THE EYE**

# Acoustic solutions for an ideal cooperation of communication and concentration.

**TERIO PLUS** is a high-quality partition wall system for visual and acoustic shielding of work areas. However, movable partition walls are sometimes not sufficient, especially in rooms with high ceilings. For this reason, **TERIO PLUS** includes everything you need for optimal room acoustics.



Wall absorbers improve the room acoustics and can also be designed with individual fabrics and patterns and images. This not only sounds good, but is also a great eyecatcher.



Especially in confined work environments our acoustic systems ensure noticeable noise reduction and provide more privacy.



In our Rehna plant, effective acoustic components are developed on over 5,000 sqm and produced.



▶ SCAN AND WATCH VIDEO

# 67%

wish for a working environment, that promotes their creativity.\*

## CREATIVITY

According to scientific studies, 90% of the working population individualise their workplace. Against this background, a personally styled workplace can improve productivity by up to 30%. With the development of individualized office furniture we offer a wide range of different possibilities to create a creative working environment - and thus noticeably increase the personal well-being and the effectiveness in the office.

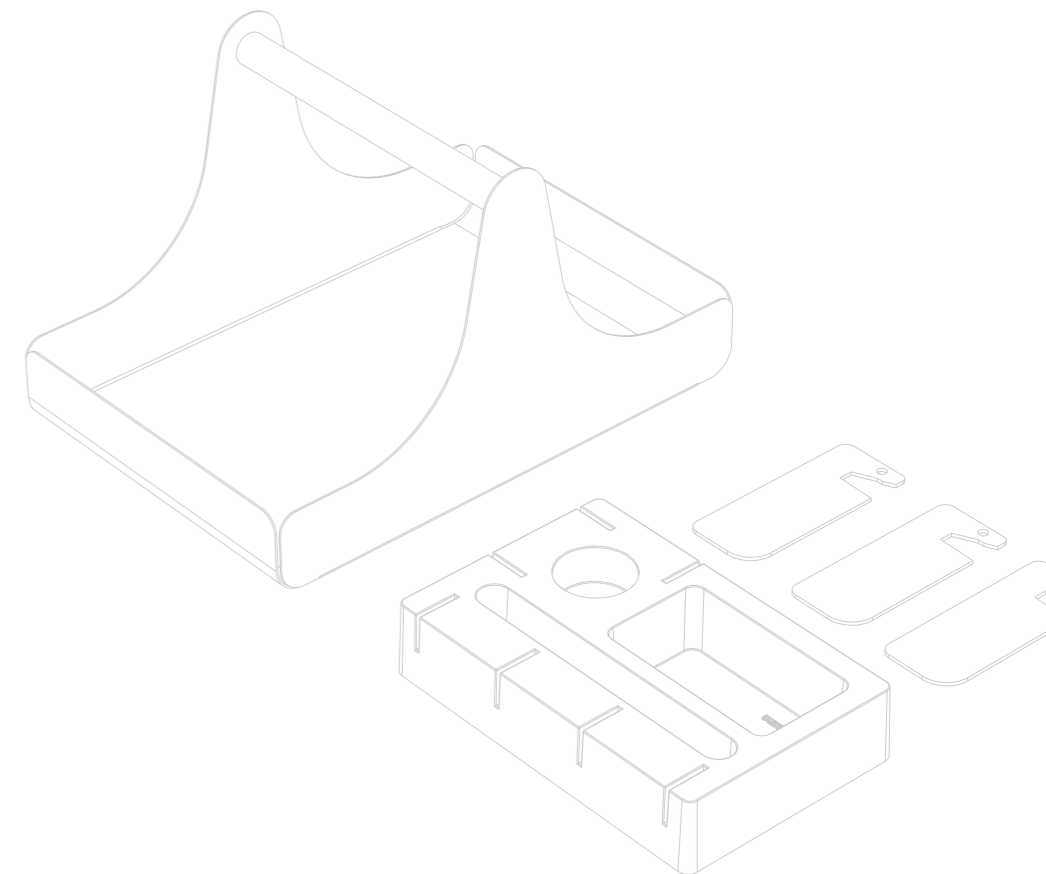



## More flexibility for every working environment

Thanks to our versatile solutions for hotdesk and open office landscapes, there is enough freedom for (almost) every maverick. With the multitude of modern work architectures, however, the feel-good factor of each individual employee is the most important thing to us. That is why the individual creative leeway plays a central role in every new concept.

**LOCKER:** Free standing as room dividers with colour accents, there are no limits to your creativity.

An optimal addition to your office: the rollable stool „FIFFI” from the ORGA-PLUS series, with additional storage space and a comfortable seat.



**GERMAN  
DESIGN  
AWARD  
WINNER  
2018**

**BRIC:** Many colour and configuration options not only create space and order on desks and in mobile containers, but also offer endless room for personal creativity.

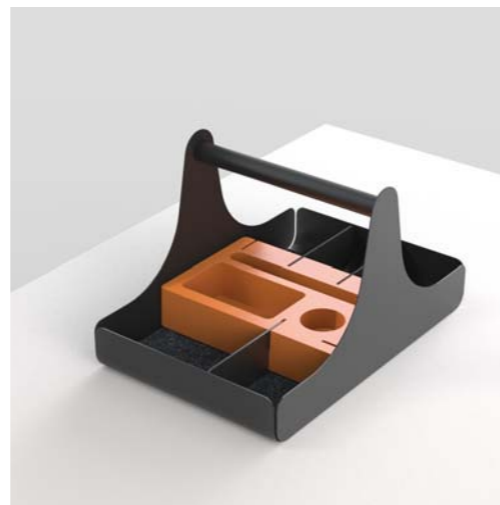
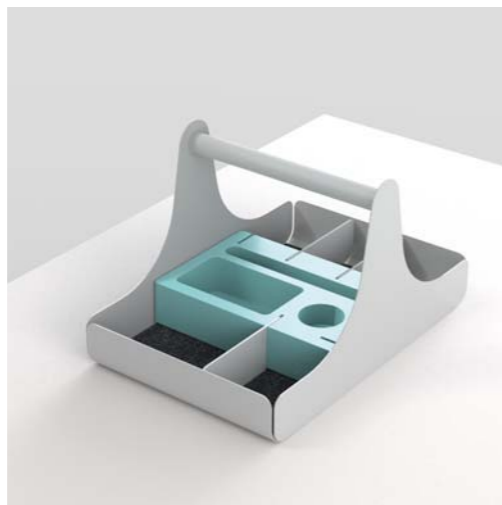

**FUNCTIONAL MEETS COMFORTABLE -  
THE SECRET RECIPE FOR CREATIVITY**



# Unlimited creativity

More open working environments and the increase in collaborative projects require not only changes in the individual work areas, but also a change in the entire office space through a greater availability of meeting areas.

**P4** is a modular shelving system in frame construction that adapts unconditionally to your creative ideas. Refreshingly reduced and with straight practicality, **P4** meets all requirements of modern and functional room planning.



P4 offers unlimited possibilities for more cosiness in everyday working life: whether as an individually easily extendable storage space at the workplace, as a homely room divider or as a hanging shelf and sideboard in the reception, catering or break area.

In combination with the soft seating MELOUNGE, the office radiates a modern, homelike environment in which ideas bubble over.



▶ SCAN AND WATCH VIDEO

# 51%

of companies want to improve their internal communication.\*

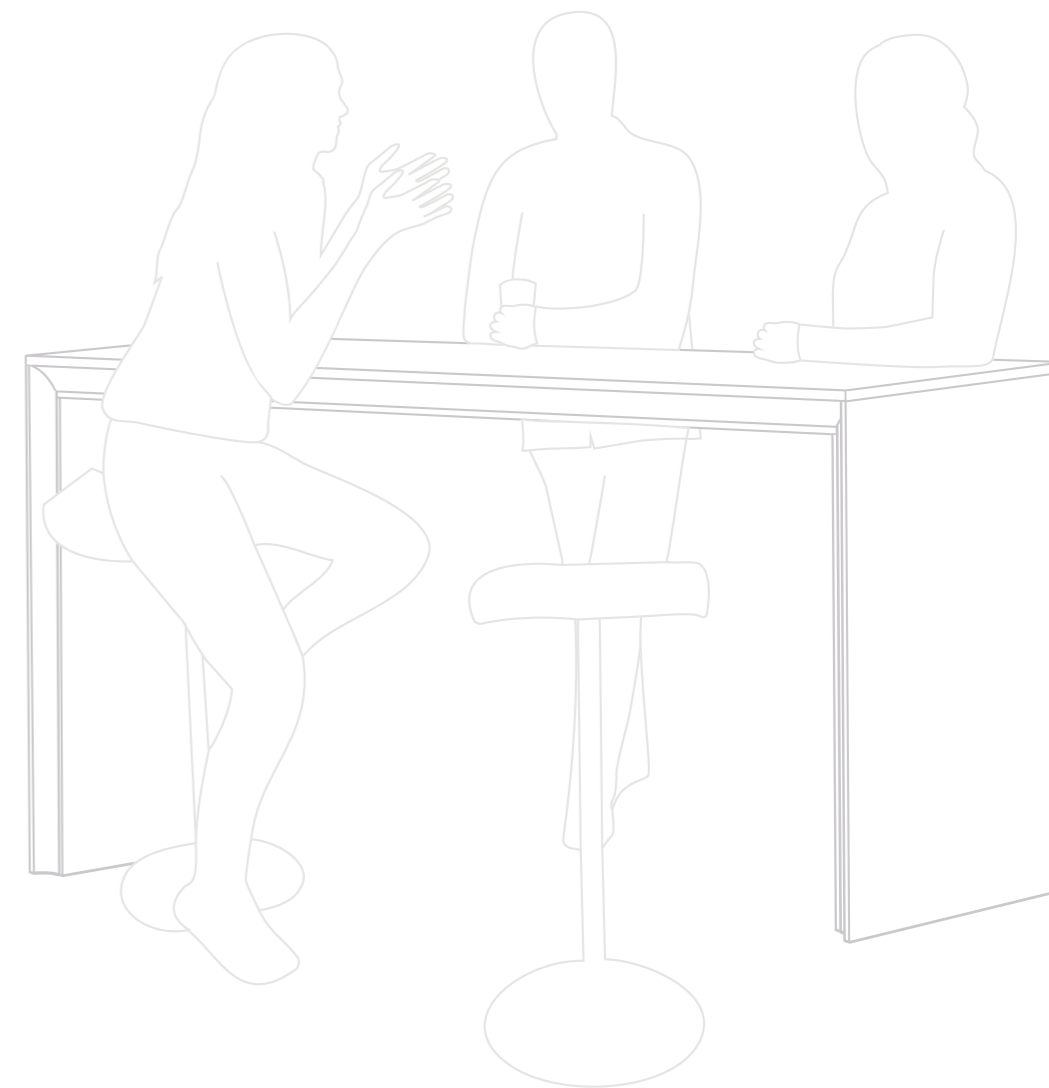

## COMMUNICATION

Granted: an office kitchen is not the first thing you think of when optimizing the flow of communication. But just remember your last party - exactly. A casual exchange of ideas and direct contact creates space for personal matters and stimulates brain activity. It has been proven that 80% of all ideas are generated in informal exchanges. With optimised office furnishings you can make a significant contribution to an improved flow of information - a good idea for good ideas.





## Make the kitchen to your **Think Tank.**

Whether black, with milk or sugar: for many employees, a cup of coffee is a real Energy boost at work. **CUCINA** turns neglected coffee kitchens into true feel good hotspots. No matter whether gossip, short project meetings or during the lunch break. A kitchen inspires and brings people together.

The high functional quality, the beautiful surfaces and the variety of options up to a fully equipped kitchen make the **CUCINA** system a comprehensive office pleasure.





## Build „bridges“ for your communication!

**KIT** as a freestanding solution is as practicable as a wall-bound or docked element. It builds a bridge between concentrated office work and communicative exchange.

The high table is fully electrified and offers all relevant interfaces to the modern media world. This makes it ideal for a quick meeting or a small laptop presentation while standing.



## EXACTLY YOUR CUP OF TEA

**An office kitchen clears the mind -  
CUCINA also keeps the work surfaces clean.**

**CUCINA** is deceptively large: the drawers are optimally partitioned. Behind the front panels there is sufficient space for standard built-in appliances such as a refrigerator, microwave or fully automatic coffee machine. This means that the days of piled office kitchens are finally over.





▶ SCAN AND WATCH VIDEO

# 90%

of employees individualise their work area.\*

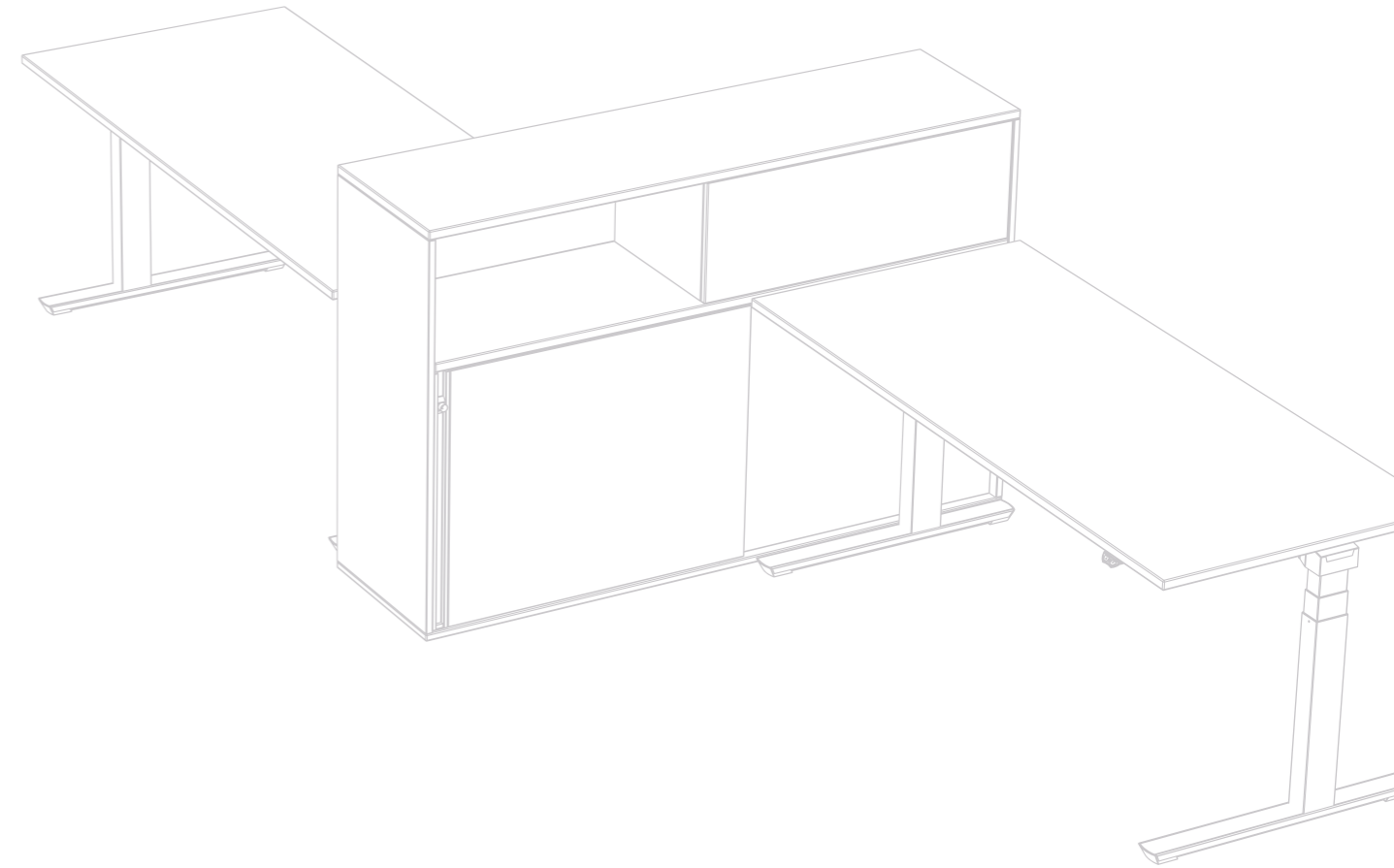

## INDIVIDUALISATION

Successful teams consist of people with very individual personalities and skills. To make teamwork successful and fun, more and more companies are opting for office workplaces that meet a wide range of requirements. Our collaboration and storage solutions offer your teams the opportunity for a fast and open exchange of knowledge and creativity - and at the same time every team member can be exactly as they are.

We make loners  
to team players.

PALMBERG knows the wants and needs of office-workers 42% of employees want more personal contact with their colleagues. A quick coordination in between a question, a shared laugh - it can be so easy to change the atmosphere in the office. The functional cabinets of the **PRISMA 2** series turns employees into colleagues, because the mutually operable cabinets not only offer sufficient space for personal belongings, but also a platform for all kinds of communication.

Separate but still together: The middle console can be operated from both sides. Thus, users can set-up their workplace according to their own taste.



CREW-Bench solutions can be easily adapted to the needs of the respective employees and their specific tasks.

In connection with the partition wall system **TERIO PLUS**, individual delimitations are easily integrated into the daily work without losing sight of colleagues.





▶ SCAN AND WATCH VIDEO

Height-adjustable tables increase the performance by up to

**45%.\***

## WELLBEING

The personal feel good factor in the office is not only affected by the individual creative freedom, but also considerably by ergonomic aspects. For example those, who often feel tired in the office, sit too often and long. An American study showed that sitting/standing tables can increase performance by 10%. Therefore, with a height-adjustable desk you not only bring more dynamism into the office, but also more efficiency.

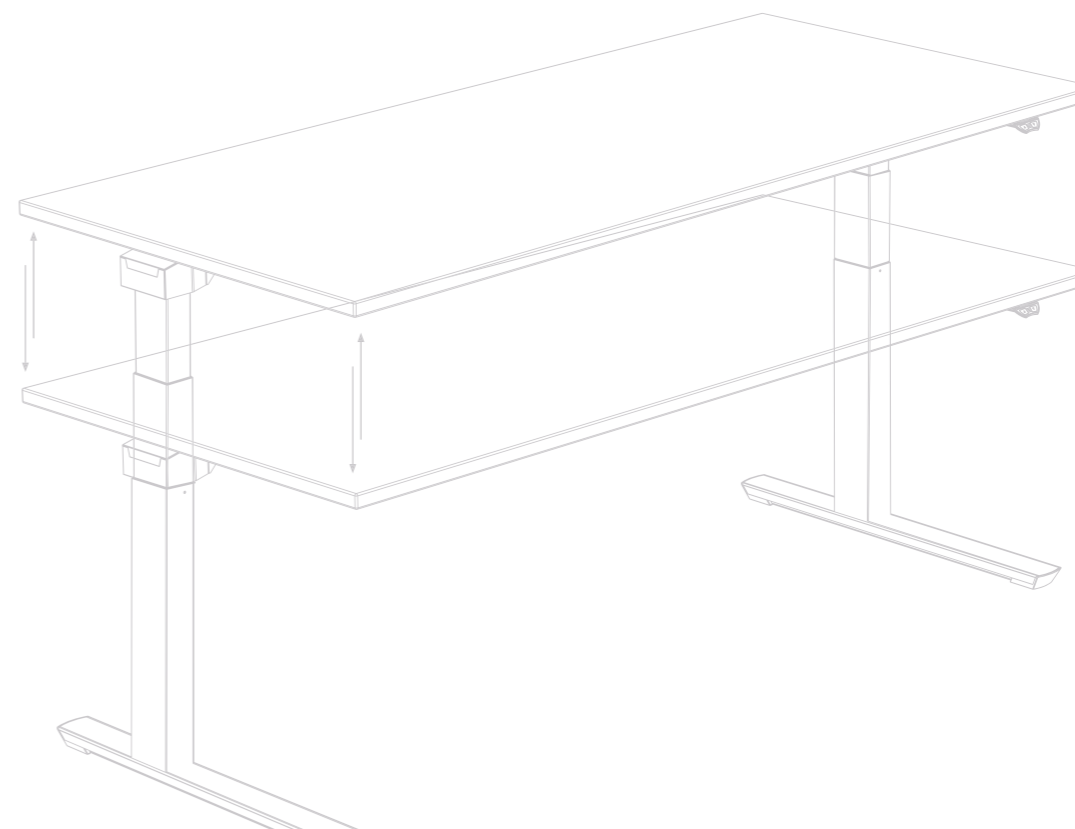



An ergonomic workplace design can be quickly achieved, even without electricity, by releasing a gas pressure spring, via Easy Push system or a crank - with our electromotive sitting/standing tables you can change your position even more comfortably.

## Gain height - with our height adjustable tables

According to a Forsa survey for the Techniker Krankenkasse 56% spend almost their entire working time sitting. It has been proven that sitting makes people faster and easier tired. A fully ergonomic workstation with height-adjustable table makes it possible to switch between sitting and standing activities at any time without effort.

**CREW** and **CALDO** offer a freely adjustable range between 650 and 1250 mm through a stepless height adjustment - health promotion can be so easy.

Dynamism is a question of  
the position.



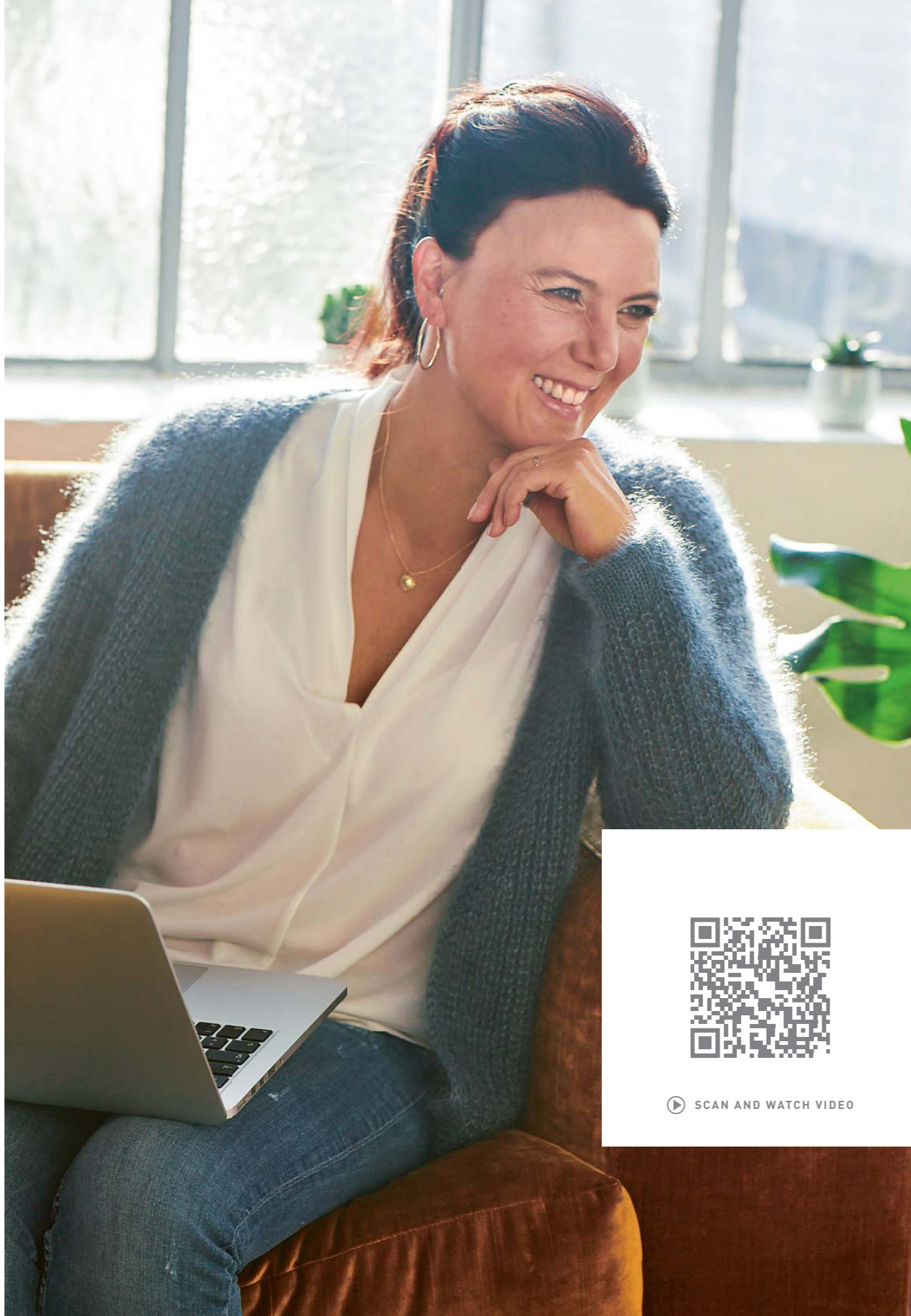

▶ SCAN AND WATCH VIDEO

**78%**  
wish for a working  
environment with  
possibilities to  
retreat.\*

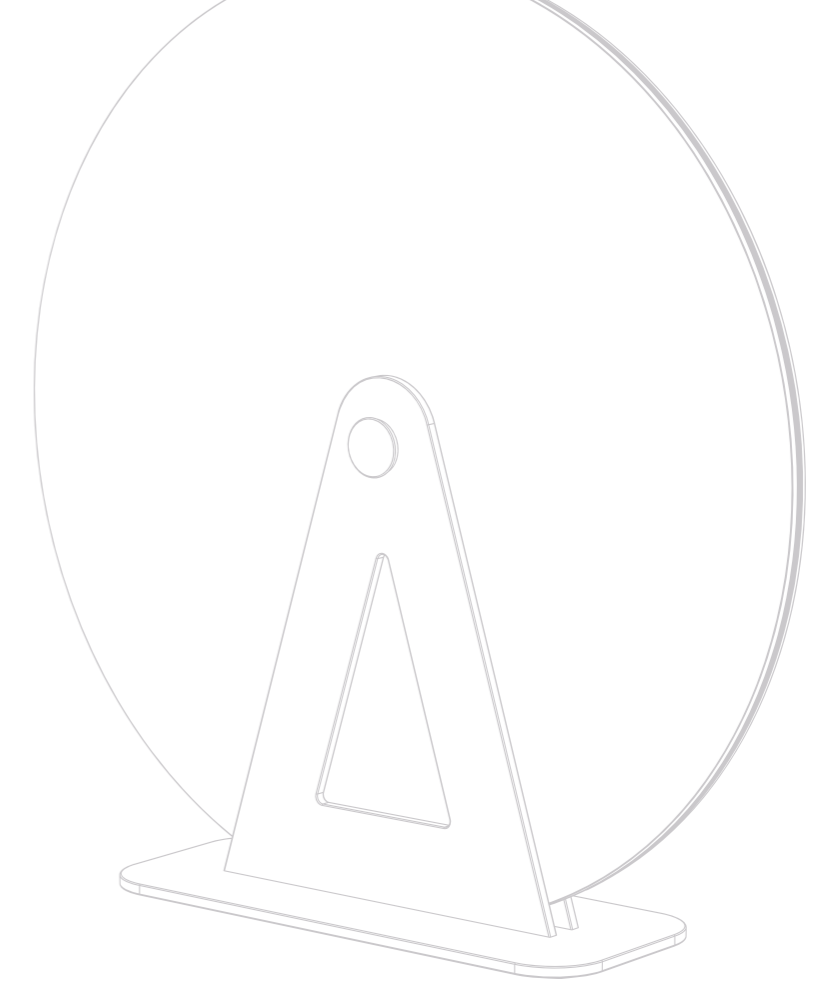

## LOUNGE & RELAX

Innovations in working environments dramatically lag behind the dynamics of New Work. The majority of employees prefer open space offices as long as there are opportunities for retreat. Breaks and meetings with colleagues increase satisfaction and lead to a higher quality of work. Therefore, office environments should be flexible and homely to become a place where employees enjoy spending time.



Concentration is just a turn away

Privacy screen, sound absorber, room divider and design element at the same time - this is what makes the mobile room divider **DISC** so distinctive. The circular disc is extremely variable in its application possibilities and can be easily and conveniently rolled from A to B. This not only improves the acoustics, but also creates flexible areas for concentration and wellbeing.



Awarded for innovative and groundbreaking design, DISC, with a diameter of 160 cm and pinable fabric coverings in a wide range of colours can be used for everything from prestigious reception, areas and relax zones areas to open-plan offices.



Seating comfort  
at all levels

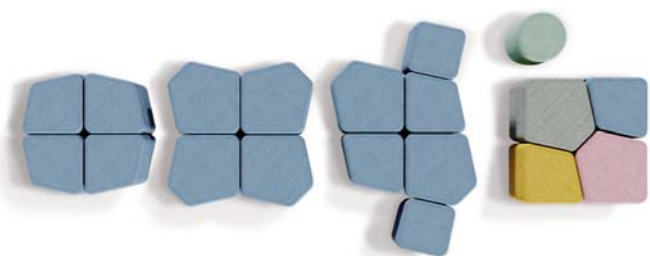

**We call it „flexible living“.**

A perfect mixture of homely and flexible. The completely upholstered softseating collection **MELOUNGE** can be rearranged over and over again, it offers seating comfort and gives a homely character to any environment. Create an alternative place to work and relax.

**FEEL GOOD ALL  
ROUND**



A man cannot  
be comfortable  
without his  
own approval.

Mark Twain



**When actually do people look forward to the office?** The managing directors of PALMBERG, Nicole Eggert and Julianne Utz-Preußing, have responded with a clear answer: If you really feel comfortable there.

**Ms. Utz-Preußing, Ms. Eggert, what does the „Feel-good Initiative“ of PALMBERG exactly mean?**

**J. Utz-Preußing:** When you put it that way, it sounds like a short-term idea, a marketing tool. But it's not. Over the past few months, we have spent a lot of time thinking about our philosophy and what it is all about when we produce office furniture. It has become clear:

■ *No matter what we do, it must make sure that people in the office feel better. That they feel comfortable.*

All functionalities, developments and innovations must be subordinated to this purpose.

**N. Eggert:** This is essentially what we want to express with our claim „I look forward to the office“. Today, office furniture should fulfil a wide range of tasks: They have to facilitate internal communication, enable teamwork, but at the same time create space for concentrated individual work.

They should promote health, optimise acoustics, be flexible and space saving. And, not to forget, look good and represent the company values. But what is the common denominator of all these functionalities?

The improvement of the feel good atmosphere in the office. That is our goal.

**But how do you know what people expect from an office? When do they feel comfortable?**

**J. Utz-Preußing:** Of course we have a lot of experience - after all, furniture has been built at PALMBERG since 1921. But we do not rely on this experience alone.

First and foremost, we listen to our customers very carefully and ask specific questions. What is needed? What can we do better? In addition, we constantly scan the market, collect studies from renowned market research institutes and work closely with universities and technical colleges. In this way, we identify the challenges offices are facing today.

We collect all these results in a large database and incorporate them into our developments.



For the 100th Bauhaus anniversary PALMBERG cooperates with the design department of the Anhalt University of Applied Sciences in Dessau. Students of the course of studies „Integrated Design“ develop furniture, accessories as well as innovative interior design solutions under the direction of Prof. Katja Thoring, professor for 2D/3D design and experimental design, solutions and visions for the office of the future.

**daily ex works:**

- 25 Trucks
- 300 Office container
- 700 Desks
- 800 Office cabinets
- 250 Acoustic elements
- 230 Communication furniture



**N. Eggert:** Every type of office has advantages and disadvantages, whether one-person office open plan office or hot desk concepts where every employee looks for a new place every day.

■ *We take a close look at these different office concepts and present office furniture solutions that help to bring out the advantages even better and compensate for the disadvantages as far as possible.*

**Can you give a concrete example?**

**J. Utz-Preußing:** More and more companies are moving away from the classic individual office and choosing larger rooms in which several employees are located. We know that 52% of all employees prefer this type of office because it is more communicative and lively. At the same time, this provokes several challenges. On the one hand: the noise level. People are talking on the phone, chatting, even the click of the keyboard buttons can disturb and distract the person sitting next to typer. This can result in reduced concentration and a loss of efficiency. To counteract this, we have developed a wide range of noise reducing solutions that optimise room acoustics.

This measurably ensures that employees can concentrate better on their work again.

**N. Eggert:** In addition to the acoustics, the cosiness and friendliness of open plan offices often suffers. Many times a large room full of desks appears cold and purely functional. This is where furniture elements that bring colour and design into play may help. The soft seat cubes of the MELOUNGE series are a good example. Or the DISC room divider, which has just won the German Design Award, which also has an acoustics-improving function. These elements, available in different colours, can be moved freely in the room and have a high design standard. And: they make the office a place of well-being.



PALMBERG was once again awarded one of the most renowned international design awards. The DISC was awarded the German Design Award „Winner“ 2020 in the category „Excellent Product Design - Office Furniture“.



**Do you observe a change in office culture?**

**J. Utz-Preußing:** Absolutely. The change is huge and it is progressing. On the whole, it can be summarized under the keyword „flexibility“, which has just been mentioned.

■ *One thing is quite clear: there is no such thing as „the“ office these days.*

Today there are many different approaches - from loft like co-working spaces, open plan offices and home office solutions - all on an equal footing. But not only every office is different - each employee is different too.

And the younger generation now expects their employer to respond to individual needs. Flexible working hours, home office, height-adjustable desks, a beautiful, modern office with community and collaboration spaces - all this is almost standard today. We develop solutions for this whole range of scenarios.

**And where is the classic office?**

**N. Eggert:** That will always be there no question - it is still a core market for us. Because even a classic office can be designed in such a way that all employees feel comfortable. Flexible storage space, places of retreat, communication zones, etc.

Also, many companies are still unaware of how much a height-adjustable desk can do for the health and efficiency of employees with little effort. Here we often provide information and support to our customers right from the initial planning phase.

**Looking into the future: what plans do you have with PALMBERG?**

**J. Utz-Preußing:** Three goals have the highest priority for us:

■ *The company is to remain in family hands. We want to offer our employees a secure job and be a good employer.*

In order to achieve these goals, a decent dose of innovative spirit is required, not only to recognise the changes in the office furniture market, but also to actively develop solutions and keep up with the times. At the same time, it is important for us not to blindly follow every trend, but to make conscious decisions about what is sensible and sustainable.



We are firmly anchored in our region and have developed from our home base to one of the leading office furniture manufacturers in Europe. We want to stabilise and strengthen this market position. We are convinced that the core strategies we have built up and which have proven to be working over the last decades are still valid and justified. Maybe more than ever before. They have made PALMBERG what it is today, a certified, environmentally conscious and social company.



All our product categories are Level 2 certified at the minimum.



Our regional solidarity is also shown by the long-standing support of the women's volleyball team of SSC Palmberg Schwerin.

**J. Utz-Preußing:** These strategies include, for example, not throwing our sales principles overboard for short-term profit. Our Specialist dealers are our partners.

Thanks to this very close cooperation, we are able to offer our end customers a first class on site service. They benefit from individual support with exceptionally good accessibility, a high reaction and processing speed as well as great flexibility with regard to special solutions.

In addition, our own fleet of more than 100 truck trailers gives us great logistical independence, which results in an unparalleled high level of delivery punctuality, even for major projects. Because some things will not change at PALMBERG in the future. And this includes that we are a partner you can rely on 100%.

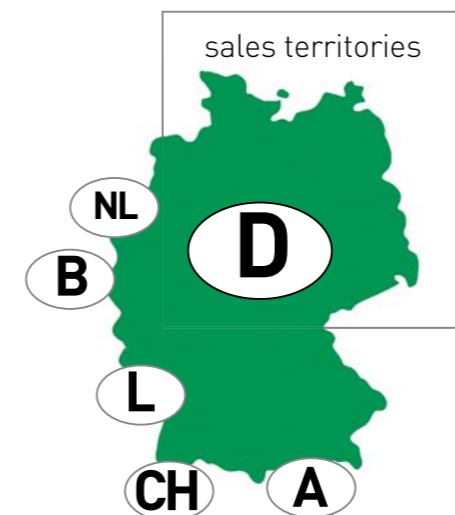

**570**  
committed employees  
(including **33** apprentices)

**N. Eggert:** Sustainability is a good keyword in modern times. Our company has been characterised by healthy and sustainable growth for years.



VISIT US IN  
OUR SHOWROOMS.

SCHÖNBERG  
REHNA  
HAMBURG  
DÜSSELDORF  
BERLIN  
MUNICH  
STUTT GART  
FRANKFURT  
SWITZERLAND  
NETHERLANDS



OR ON  
PALMBERG.EU

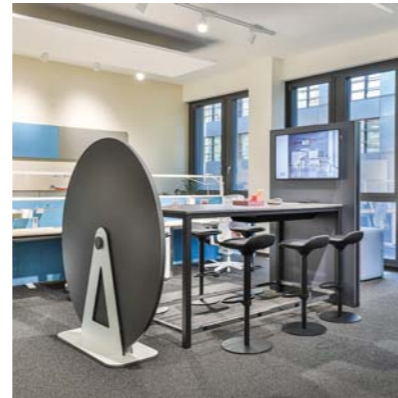

#### IMPRINT

##### Publisher

PALMBERG Büroeinrichtungen + Service GmbH  
Am Palmberg 9 · 23923 Schönberg · DE  
Tel. +49 38828 38-0 · Fax +49 38828 38-136  
www.palmberg.eu · info@palmberg.eu

##### Responsible

Christoffer Süß  
Director of Marketing

##### Conception

Schmidt-Ohm + Partner Werbeagentur GmbH  
www.sop-hamburg.de

##### Pressure

Dräger + Wullenwever  
print + media  
www.draeger-wullenwever.de

##### Picture credits

© Palmberg  
© iStock  
© Florian Grill - photography | motion  
© CASA - Studio für Interieurfotografie  
© emotions4life - Studio für Werbefotografie  
© Central Studios  
© Karsten Eggert - Mediakonsum  
© Fotowerker  
© Felix Matthies - STUDIO HOHELUFT  
© Eckhard Mai

##### Picture credits references

© WAREMA - Ingo Peters Photography  
© Hunkemöller & AXA - Andrea Dingeldein  
© Etex, Hafenhuis & HoGent - Sarah Blee  
© Coca Cola - Werner Huthmacher  
© Festival MV Schwerin - Oliver Borchert  
© Feuerwehr Hasselt - Raf Beckers, Artimodus  
© Van Vlierden - Van Vlierden, Neerpelt  
© Euroimmun - Stephan Kühl

##### Gender reference

For reasons of readability, no gender neutral differentiation is made. Corresponding terms apply in principle to all genders.



We protect the environment!  
This product is made from FSC-  
certified wood.